

WARNING

1. To avoid electric shock, disconnect power at source prior to installation.
2. The installation should be performed by qualified electricians or lighting technicians.
3. Before conducting any installation, maintenance, or removal, disable all power to the luminaires and wait until the fixture cools down.
4. Do not touch the fixture while it is in service.
5. If there is any problem with the fixture, DO turn off power and DO NOT attempt repair unless you are a qualified technician or the manufacturer.

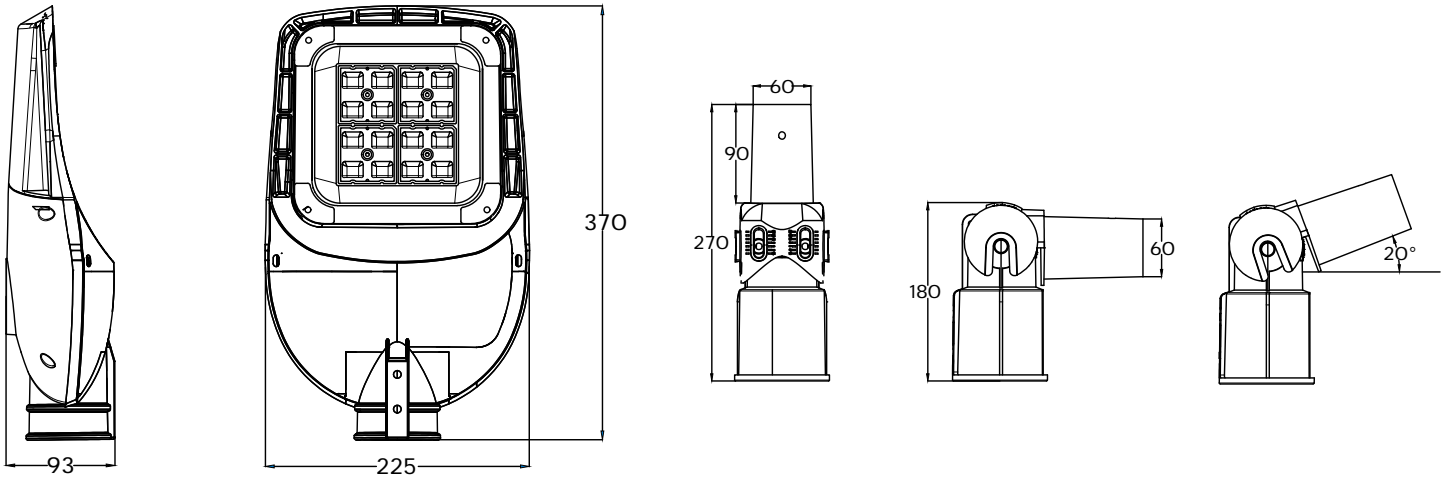

Optional Adjustable Bracket

Side-entry Installation

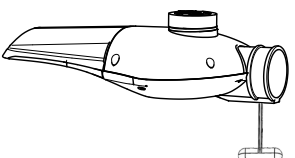
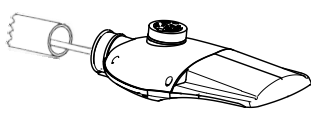
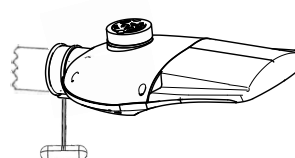
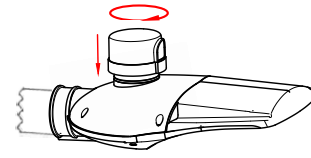
 <p>1. Use a 4mm Allen Key, loosen all the grub screws sufficiently to allow for the column bracket diameter.</p>	 <p>2. Feed the mains cable into the column and offer the spigot up to the column bracket (up to 60mm diameter). Power and make appropriate waterproof measures to maintain the same IP rating.</p> <p> ■ BLUE (ACN) ■ YELLOW/GREEN (GND) ■ BROWN (ACL) </p>
 <p>3. Once the fitting is level, fully tighten the grub screws to a maximum 11Nm - STRICTLY DO NOT OVERTIGHTEN.</p>	 <p>4. Fit dusk till dawn photocell sensor or shorting cap into the nema socket. Twist clockwise to lock it.</p>

Post-top Installation

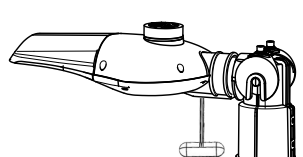
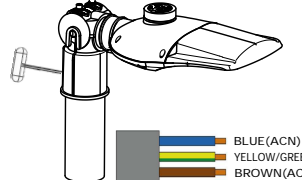
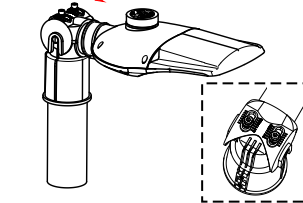
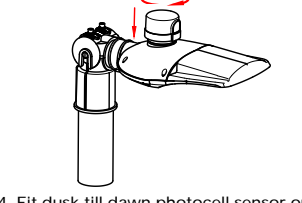
 <p>1. Using a 4mm Allen Key, Fix the fitting on the adjustable bracket by fully tightening the grub screws once the fitting is level. Maximum 11Nm - STRICTLY DO NOT OVERTIGHTEN.</p>	 <p>2. Feed the mains cable into the column and offer the adjustable bracket up to the column (up to 76mm diameter). Power and make appropriate waterproof measures to maintain the same IP rating.</p> <p> ■ BLUE (ACN) ■ YELLOW/GREEN (GND) ■ BROWN (ACL) </p>
 <p>3. Raise or lower the lighting head as needed in 5° increments from -10° to +20°.</p>	 <p>4. Fit dusk till dawn photocell sensor or shorting cap into the nema socket. Twist clockwise to lock it.</p>

Luminaire must be operated within an ambient fixture temperature of -20°C to 50°C to comply with all safety and warranty regulations. Ensure sufficient air flow around the luminaire for efficient heat dissipation. Failure to do so could significantly reduce luminaire life and/or safety/warranty regulations.

NOTE: Installation of LED luminaire with modification to the unit, or incorrect fitting in accordance with the above instructions could result in damage/failure of the luminaire, which may invalidate warranty.

MANUFACTURER'S GUARANTEE

This product is guaranteed in the country of purchase for the number of years as stated from the date of purchase. The guarantee is invalid in the case of improper use, installation, tampering, removal of the Q.C. date label, installation in an improper working environment or installation not in accordance with the advised instructions and/or national wiring regulations. Should this product fail during the guarantee period it will be replaced free of charge, subject to correct installation and return of the faulty unit. We do not accept responsibility for any installation costs associated with the replacement of this product. This warranty is in addition to the statutory rights in your country of purchase and reserve the right to alter specifications without prior notice.